

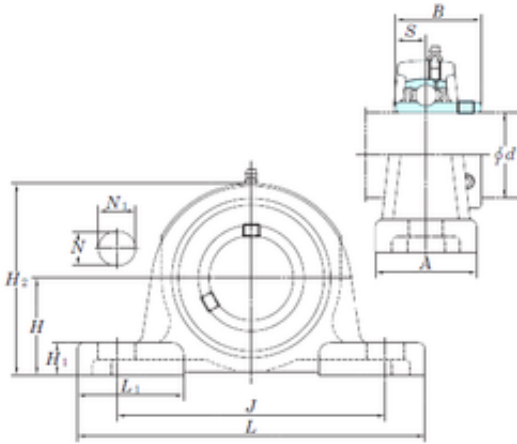

China 6206 Bearing Supplier



UCP328 Bearing 2D drawings and 3D CAD models

NSK NTN Koyo Asahi SKF Pillow Block Bearing Chrome Steel UCP328

Bearing No. UCP328

Bore Diameter	140 mm
Width	145 mm
d	140 mm
A	140 mm
B	145 mm
H	200 mm
H1	60 mm
H2	393 mm
J	500 mm
L	620 mm
L1	185 mm
N	40 mm
N1	55 mm
S	59 mm
Bolt (G)	M33
Weight	92,5 Kg
Basic dynamic load rating (C)	253 kN
Basic static load rating (C0)	246 kN
Bearing No.	UCP328
Bolt size	M33
Cr	253
C0r	246
f0	13.6
(Refer.) Unit mass(kg)	92.5
Nipple size	R1/8



China 6206 Bearing Supplier